

USER'S MANUAL

By **SOLARDIREKT24 GMBH**

Tel: 06732 / 608 99 99

Fax: 06732 / 608 99 98

E-Mail: info@solardirekt24.de

All In One Heat Pump 300L For Domestic Hot Water



This manual is applicant for the modes of:

EUROTHERM HP300-B1 (220V/50HZ/1phase)

Thank you very much for purchasing our product, please keep and read this manual carefully before you install heat pump.

NOTES

Dear customers,

Thank you for selecting our products!

The manual is aim to let you learn more installation, operation and maintenance of heat pump and provides some important safe information for you. It's quite required to carefully read the whole contents shown in this manual before you install and use heat pump, and please keep this installation manual carefully for purpose of future reference.

CONTENT

Safety Precautions	1
General Information	2
Part Names	6
Installation of Heat Pump	6
Pipe line Connection	11
Connection of Electric	14
Method of Application	17
Instruction of Operation	19
Pilot run of Heat Pump	32
Maintenance and Solution	32
After-sale Service	34

Safety Precautions

● Please make sure you have read at least one chapter of safety precautions shown in the manual. This part provides quite important safe points for you and please operate it based on safety precautions.

Warning

1. Household electric must have a reliable ground connection;

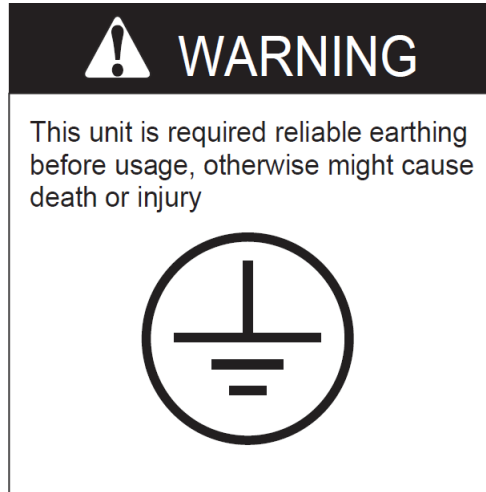

2. Household electric must install leakage protection device;

3. Do not dismantle any permanent instruction, label or parameter plate attached in the outside cover or all kinds of internal plate of heat pump;

4. Please entrust dealer or professional personnel to install the device; Installer must have professional knowledge, any improper operation by yourself may cause a fire, electric shock, injured or leakage etc.;

5. Purchased from the local market must select specified product by our company;

6. Please obey the local regulations issued by electric company to connect power supply;

7. When needed remove or re-install heat pump, please entrust dealer or professional personnel to operate it;

8. Any self-transformation or repair is forbidden, improper repair may cause a fire, electric shock, injured or leakage etc., must entrust dealer or professional personnel to repair it;

9. Earthing pole of outlet must be reliable to connect, and rated current value should be not less than 10A, outlet and power plug must keep dry to prevent leakage, and make sure outlet and power plug are well matched.

10. Place or wall which the water source may spatter into, the installation height of power plug is not less than 1.8m and make water source and power plug keep a certain distance, meanwhile make sure children are out of touch;

11. One way valve specified by our company must be installed near to cold water outlet;

12. In the state of energization and heating.

General Information

I. Measurement

Model	Weight(kg)	Dimension(mm,DxH)	Power supply
EUROTHERM HP300-B1	130	620x2038	220V/ 50Hz/ 1 phase

II. External appearance



III. Features

All in one heat pump for sanitary hot water :

1. Has complete isolation between water and electricity, without electric shock problem, more safety;
2. No fuel tubes and storage, no potential danger from oil leakage, fire, explosion, and so on;



3. No potential cross contamination, the condenser coil is wrapped around the stainless tank, it is external coil, do not come in contact with water directly, more safety and health;
4. The maximum outlet water temperature: 60°C. The system makes the water be heated stably and quickly with innovative heating methods of combination the electric heating and heat pump heating properly;
5. Flexible installation achieved by long air inlet and outlet duct;

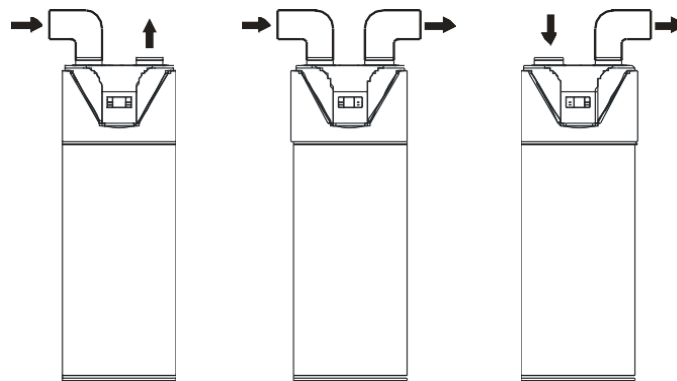

6. Automatic start-up and shutdown, automatic defrosting by revising refrigerant cycle to save the extra operation;
7. According to the heat pump principle, the unit absorbs heat from outdoor air and produce heat water thermal efficiency can be approximately 4.16 (Under the

condition A20/15°C W15/55 °C);

8. Within the temperature range from -7 °C to 43 °C, the unit will not be affected by night, cloudy sky, rain even snow weather;

IV.Refrigerant circuit

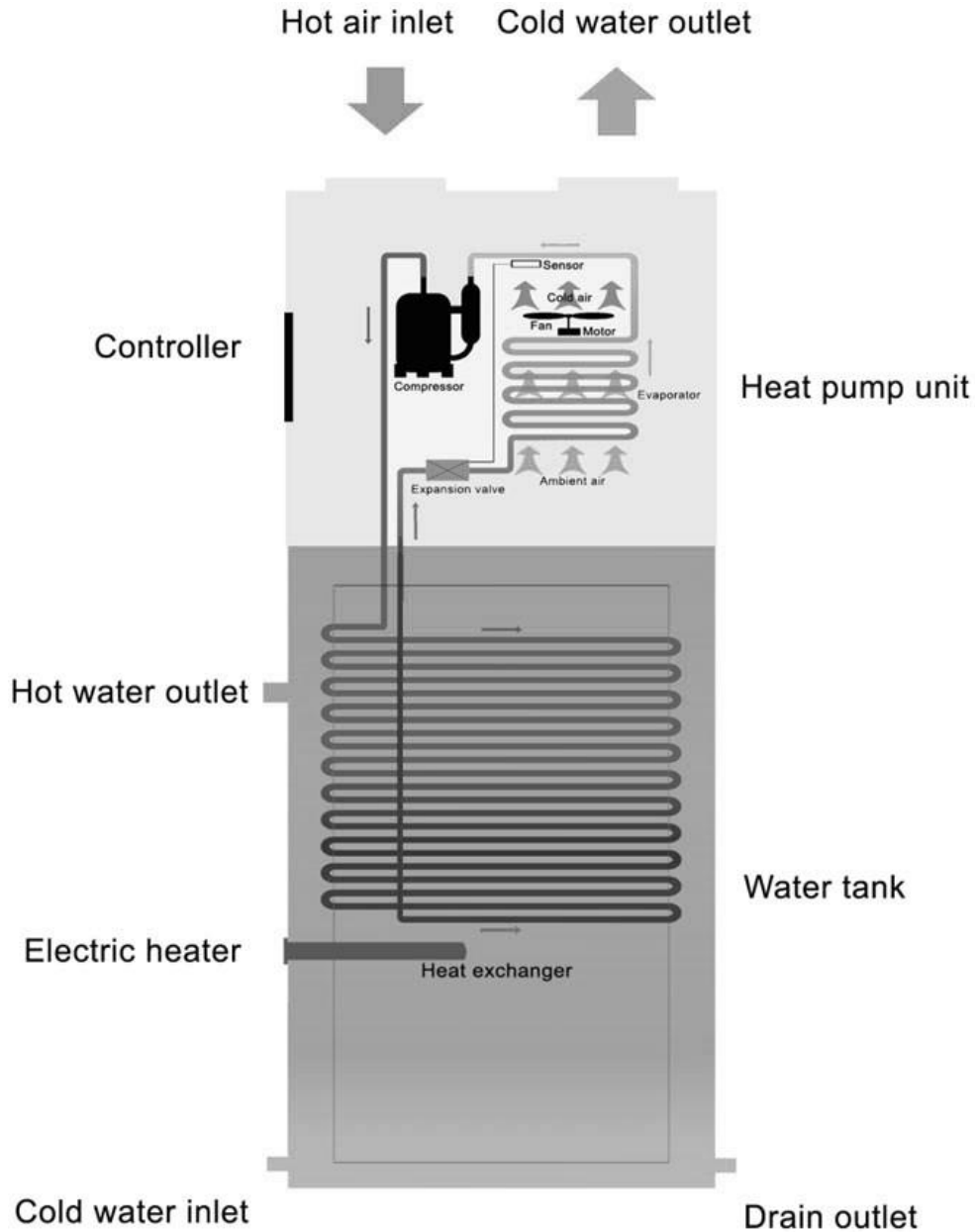

Compressor: R134A, supplied by GMCC.

Evaporator: Copper tube and aluminum fin type heat ex-changer.

EXV: Electronic expansion valve, the opening is regulated according to the discharge air temperature of compressor.

Fan: Centrifugal fan with three speeds.

High Pressure Switch: When the discharge pressure of compressor is 2.76Mpa or higher, the protection switch will be triggered, and if the discharge pressure is down to 2.07MPa, the protection switch will be recovered.

V. Specifications

Model No.	EUROTHERM HP300-B1
Heating Capacity (kW)	2.3
Power Input (Kw)	0.64
COP	3.59
Max Power Input (W)	3000
Rated Current (A)	3
Max Current (A)	15
Power Supply	220V~50Hz
Backup Electric Heater (W)	2000
Refrigerant	R134a/1050g
Compressor	Rotary / GMCC
Net Dimension(mm)	Φ620×2038
Package Dimension(mm)	700×700×2090
Net Weight(Kg)	130
Gross Weight(Kg)	140
Noise (Db)	48
Water tank volume(L)	300
Exchange coil	yes
Working temperature range (°C)	-7~43

Parts Names

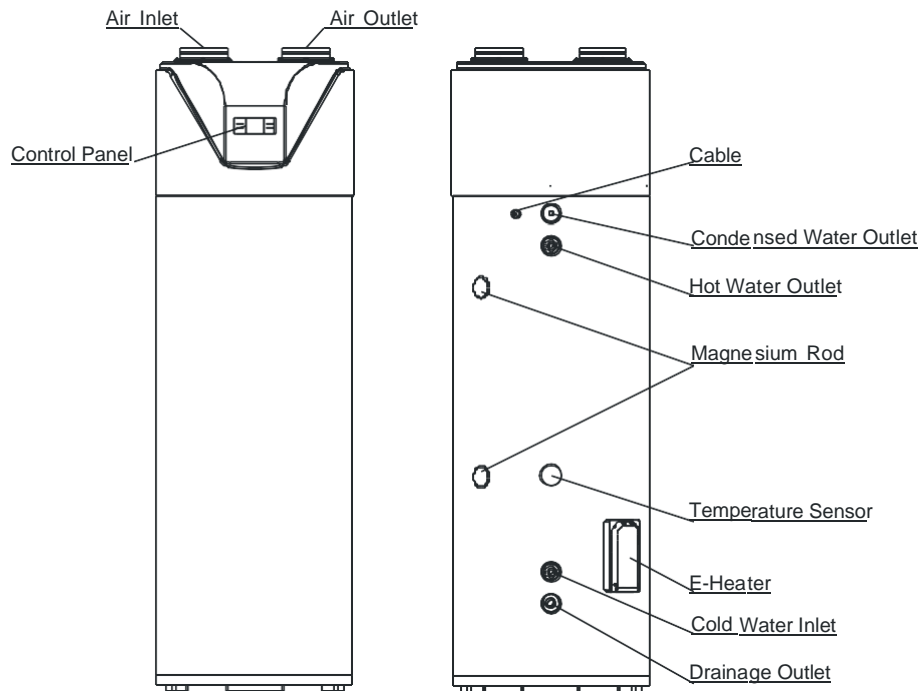

⚠ NOTE

All the pictures in this manual are for explanation purpose only. They may be slightly different from the heat pump water heater you purchased (depend on the model). Please refer to the real sample instead of the pictures of this manual.

Installation of Heat Pump

I. Choose a place

1. Do not install this equipment indoor. If installed indoor, may cause overflow, noise or indoor temperature drop which can influence your normal life, please do preventive measures in advance;
2. The place where must have enough space for installation and maintenance;
3. Inlet or outlet wind must have no obstacle and keep strong wind off;
4. Drying and ventilated place is suitable;
5. Support surface must be flat (horizontal angle must not be more than 2°), and can bear heat pump's weight and easy to install vertically, in addition, the surface will not increase any noise or shock;

6. The noise and exhausting air don't influence neighbors' normal life;
7. The place has no combustible air to leak;
8. Easy to install connection pipe and electrical parts;
9. If heat pump installed in those metal parts of the building, electrical insulation must be done well and must comply with technical standard on electrical equipment.

▲ NOTE

- In the region which the temperature is below 0 °C, the heat pump must be installed indoor or others position where will not be frozen for purpose of protecting connection pipe and keeping your normal life;
 - If used for those regions which the temperature is below 0 °C, you can take suitable measures to protect pipes in case the heat pump is installed outdoors for purpose of protecting connection pipe and keeping your normal life;
 - The place where is high temperature or long-term exposure is prohibited, or may decrease lifetime of products.
-

Notes: Installed the following places may cause machine errors. If unavoidable, please consult your local authorized service points;

- a. The place containing mineral oil such as cutting oil;
- b. The place containing salty such as seaside;
- c. The place containing corrosive smell such as spa where has sulfur gas;
- d. The place where voltage and current wave frequently;
- e. The place where has strong shake such as car or cabin;
- f. The place existing strong electromagnetic wave;
- g. The place where is full of oil gas and oil bloom such as kitchen;
- h. The place existing the evaporation of acid or alkaline gas;
- i. Others place where has special conditions.

II. The Movement of Heat Pump

1. This heat pump is heavy and need at least two people to move and install it;
2. Please move the equipment according to the state of leaving factory, and any self transformation is prohibited;
3. Please install protection plate in which heat pump is easier to touch hard objects

for purpose of avoiding scratch and deformation;

4. Do not touch fan with your hands or other objects;

5. Do not move the heat pump at the angle of 75°.



III. The Installation of Heat Pump

1. Please leave enough space to install and maintain.

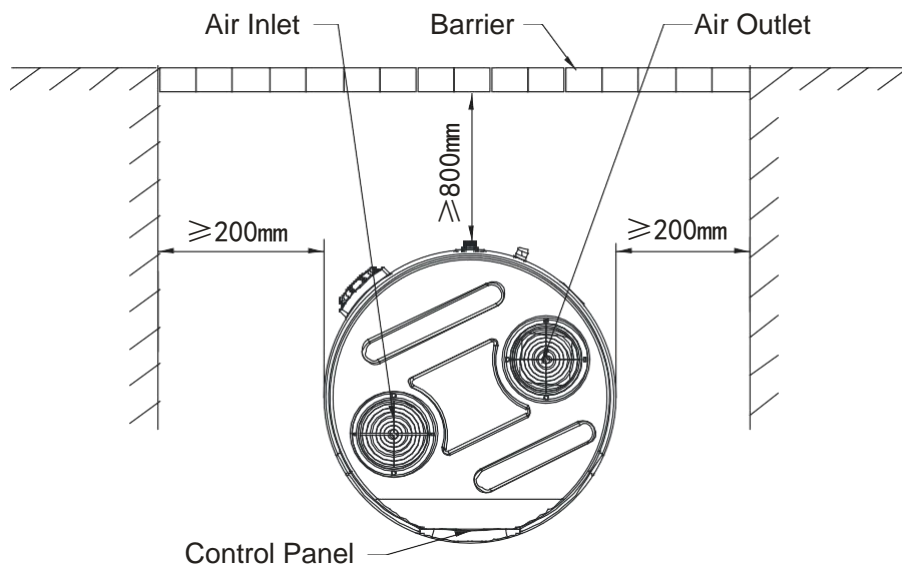

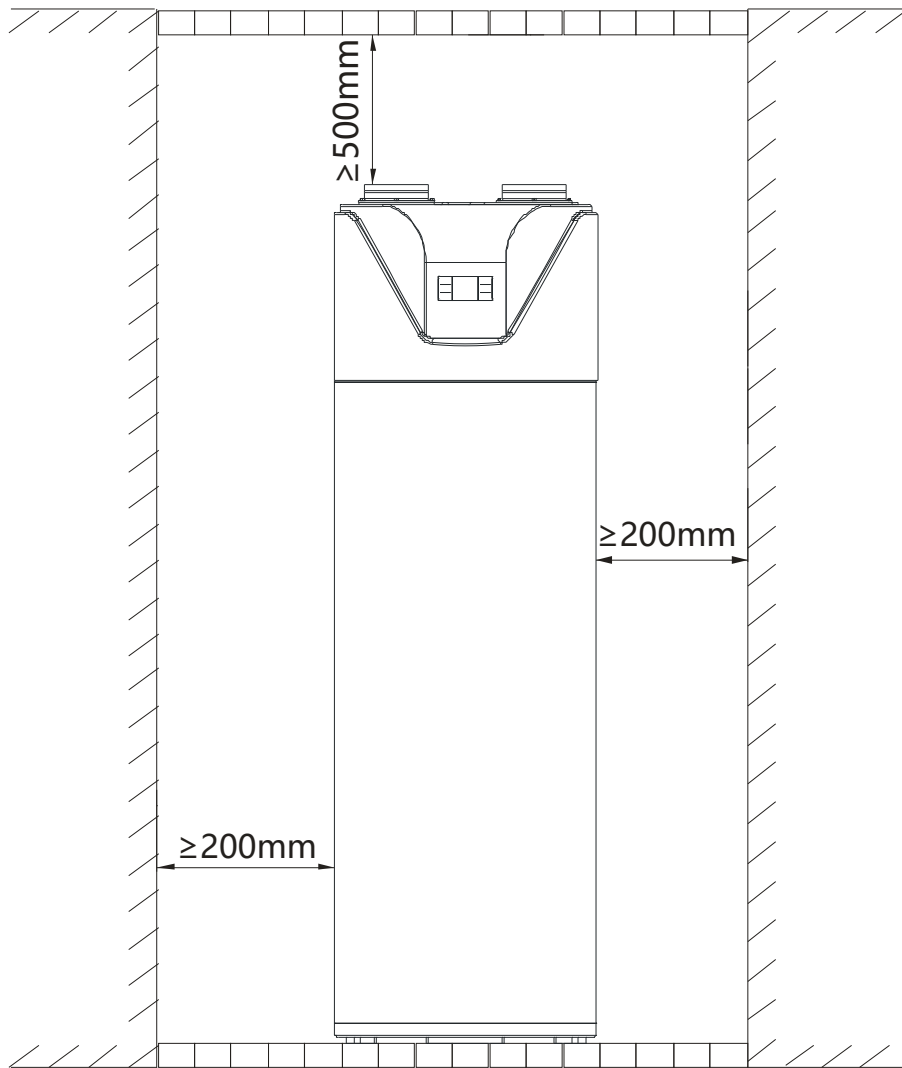

2. If heat pump installed in the basement, indoor or other airtight space, please note exhausting or intake circulation between surrounding air and outdoor air; The air duct total length should be equal or less than 6 meters, and the duct diameter should be equal or more than 150 mm.

IV. Products External Dimension

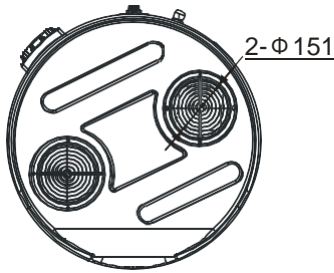
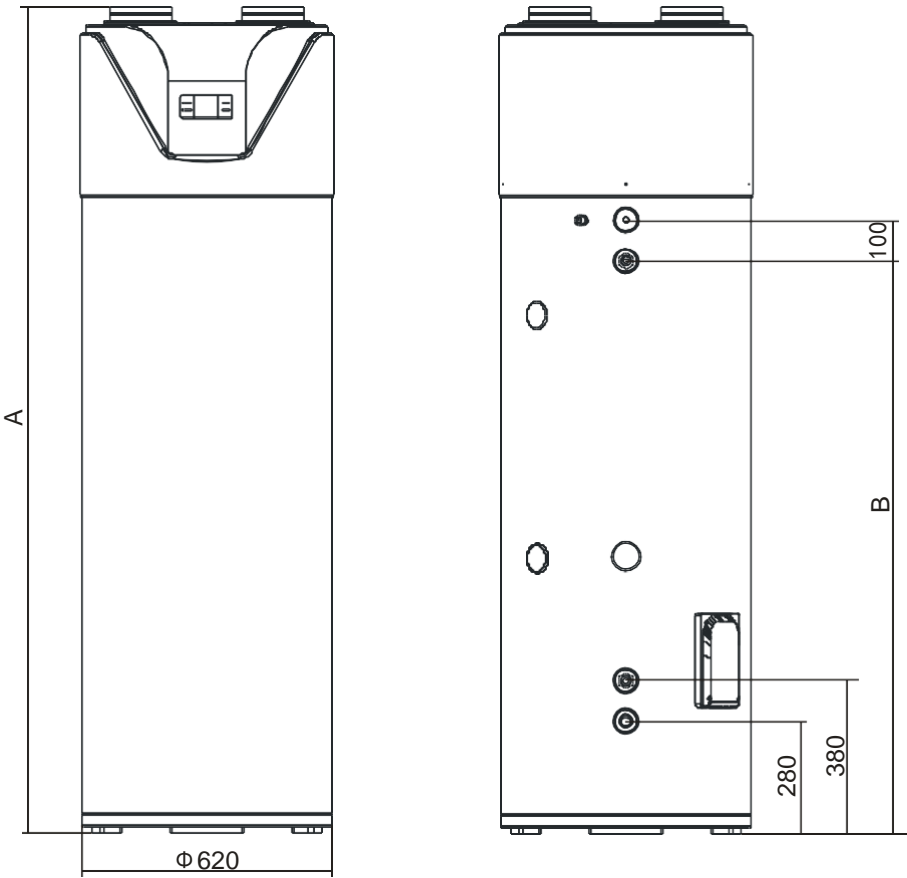

Model	Measure	A	B
EUROTHER M HP300-B1		2038	1413

Pipe Line Connection

I. Pipe Line Connection Diagram

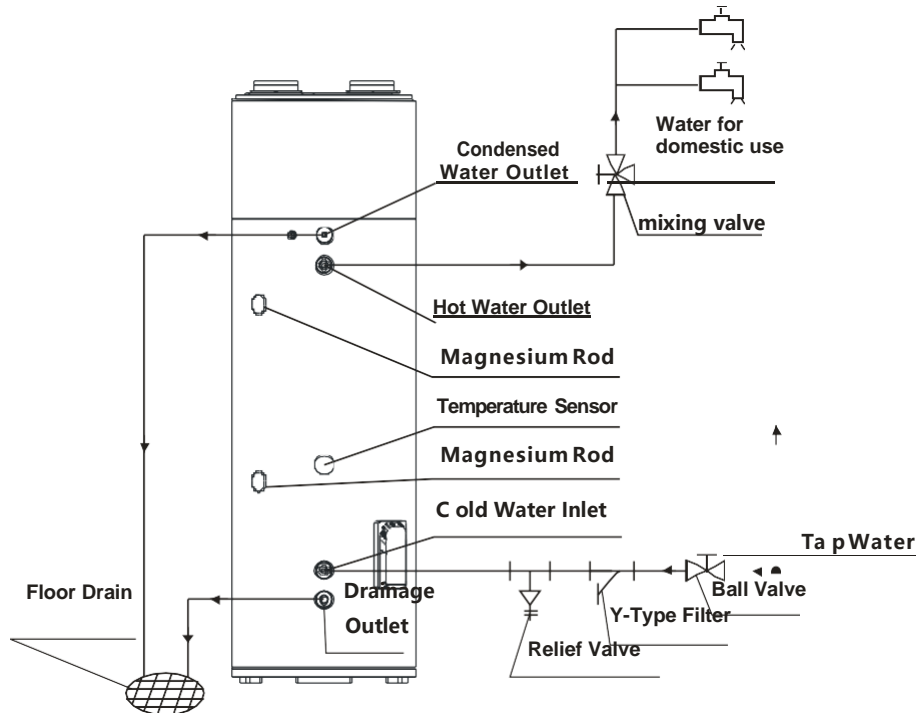

II. Water Pipe Installation Instructions

1. Please don't use iron pipe connect to heat pump, please use CPVC pipe, PPR pipe or PB pipe;
2. Please according to the drawing shows to install the water pipes, connectors etc., if the ambient temperature is below 0 °C, proper insulation must be taken for the water pipes;
3. Water inlet/outlet size is G3/4", external thread;
4. The water pipe's work life should not less than heat pump's work life;
5. Relief valve is G1/2", 0.8 MPa, after installation, must sure that the drainage pipe which connect with the relief valve, is not blocked;

⚠ NOTE

- The relief valve needs to be pulled one time every six months for purpose of taking calcium carbonate out and ensuring no obstacle, outlet temperature of drainage port may be high, please be careful;

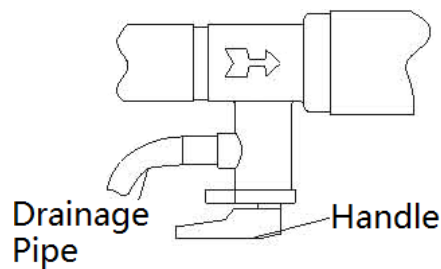

● Drainage pipe must be taken measures to keep temperature to prevent pipe from freezing to cause accident.

⚠ Danger

- Do not hold down the handle of safety valve;
- Do not knock down safety valve;
- Do not plug the drainage port;
- Excretion pipe must be connected with a open drainage port.



Explosion Danger

6. After finished all pipeline, open up the valve controlled cold water inlet and the valve controlled hot water outlet to fill water into tank, you can stop when you find water overflows from water outlet, then inspect all pipeline and make sure have no water leakage. If found leakage, you need require it well and fill water into tank again;

7. When intake pressure is below 0.15MPa, a booster pump needed to be installed to connect with inlet water pipe for purpose of obtaining larger water capacity, which can make sure intake pressure is less than 0.15MPa; When intake pressure is greater 0.65MPa, the relief valve needed to be installed to connect with inlet water pipe for purpose of keeping your water tank into a long-term working state;

8. During heat pump running, condensed water droplets may be formed, drainage water port may be unexpectedly blocked, which can make surface of equipment drop water out, to ensure your normal life and yourself equipment, we suggest water tray, please take reference to the below chart.

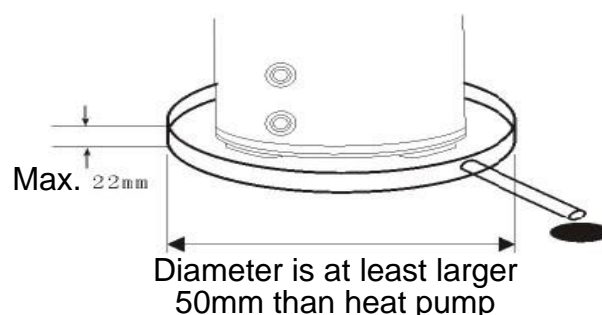

▲ NOTE

When used for the place where the temperature is below 0°C, If installed the heat pump outdoor, please take measures to protect water pipe according to local minimum temperature to prevent frozen or damage water pipe.

III. Air Duct Installation Instructions

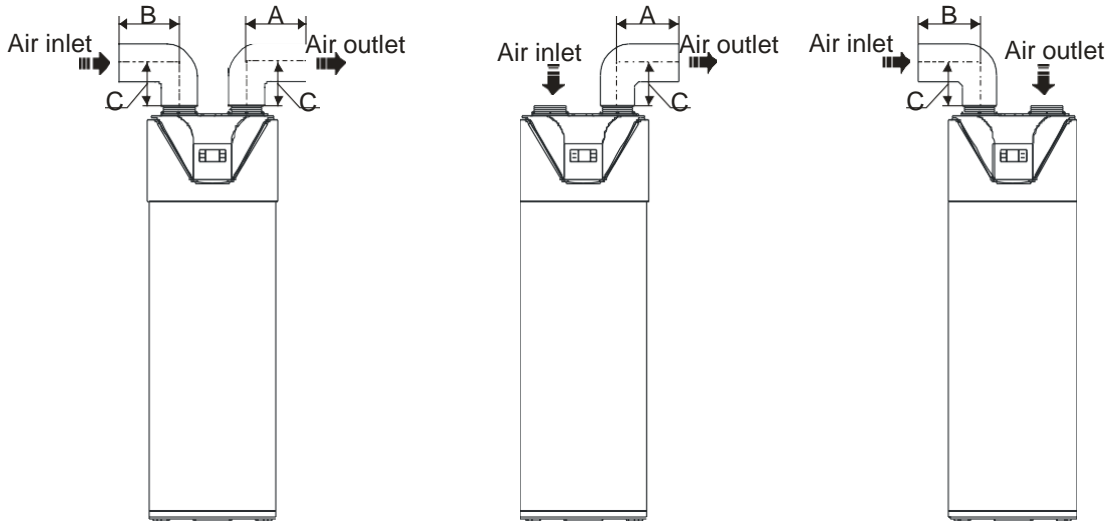

① Air inlet and outlet with duct
($A+B \leq 6m$)

② Only air outlet with duct
($A \leq 6m$)

③ Only air inlet with duct
($B \leq 6m$)

1. Scheme ② It is recommended to install unit by this way in the winter where there is other heat source in the room. (The heat pump is installed in room)
2. Scheme ③ It is recommended to install unit by this way in summer that could charge fresh cold air into room. (The heat pump is installed in room)
3. It is recommended installing the unit by only air outlet with duct (Scheme ②) in summer that could charge fresh cold air into room. (The heat pump is installed outdoor);
4. It is recommended installing the unit by only air inlet with duct Scheme ③ in winter where there is other heat source in the room. (The heat pump is installed outdoor);

5. Duct description:

Duct description	Round duct	Rectangle duct	Other shaped duct
Dimension (mm)	Φ150	150×150	Refer to above data
Straight-line pressure drop (Pa/m)	≤2	≤2	
Straight-line length (m)	≤6	≤6	
Bent pressure drop (Pa)	≤2	≤2	
Bent's quantity	≤4	≤4	

6. The resistance of duct will decrease air-flow-rate, which will lead to capacity of unit decreased, the duct total length should be no more than 6m or the maximum static pressure should within 20Pa, and the quantity bending should be no more than 3;

7. For unit air outlet with duct, when unit operating, condensate will be generated around outside of duct, please pay attention to the drainage work, we suggest to wrap the thermal insulated layer around outside if the duct;

8. It is recommended to install the unit in the indoor space. It is not allowed to install the unit at outdoor or exposed to rain;

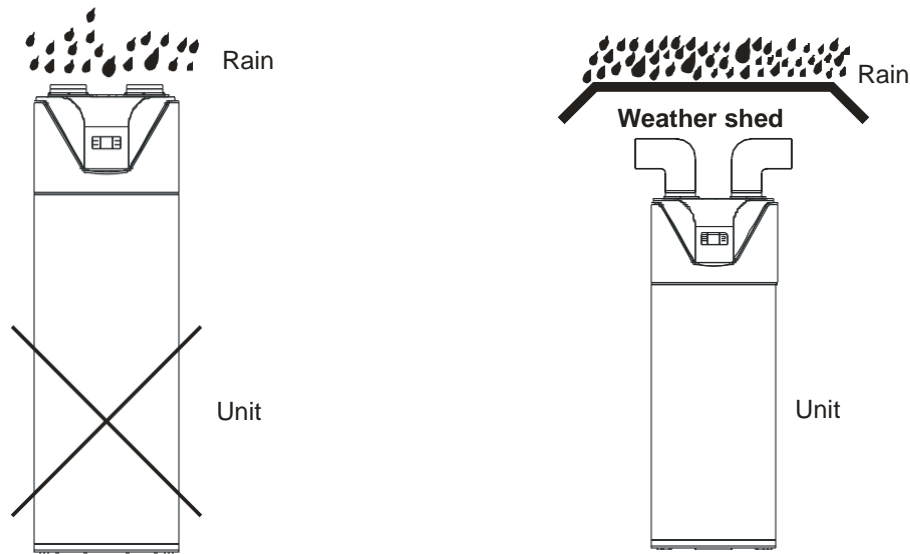

9. In terms of the main unit connect with canvas reaching to outdoor, a reliable water-resistant measure must be conduct on the duct, resist water drop into internal of the main unit;

10. Filter should be installed at the unit inlet, if the air inlet is not connected with duct. In terms of the unit with duct, filter should be put on the position of duct inlet.

Connection of Electric

● Electrical wire assembly

⚠ NOTE

● The equipment must be applied specific power supply, supply voltage must comply with rated voltage;

- Power supply circuit must be fitted with ground wire, and ground wire of power supply must be reliably connected with external ground wire;
- The operation must be worked by professional personnel based on circuit diagram;
- Set up leakage protection device well according to the National Technical Standard for electrical equipment;

1. Power Specification

Model \ Item	Power supply	The finest wire diameter (mm ²)		Manual switch (A)		Leakage protection device
		Size (continuous length ≤ 30m)	Ground wire	Capacity	Fuse	
EUROTHERM HP300-B1	220V/50Hz	≥2.5	≥Φ1.0mm	≥20	20	Below 30mA 0.1sec

Remark: Please directly connect power supply wire with user's plug when use the heat pump.

2. Leakage Protection

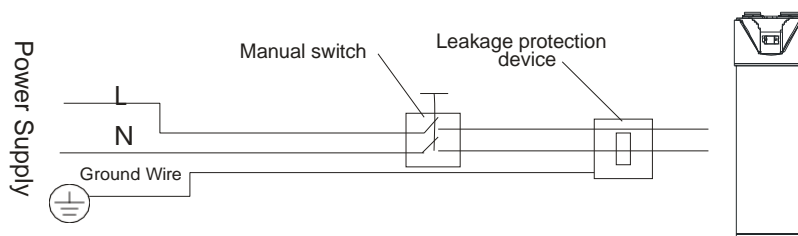

WARNING

- The external power supply box must be installed leakage protection device based on above figure for purpose of your safe;
- The equipment can be used unless you have confirmed ground wire reliably;

3. Electric PCB diagram

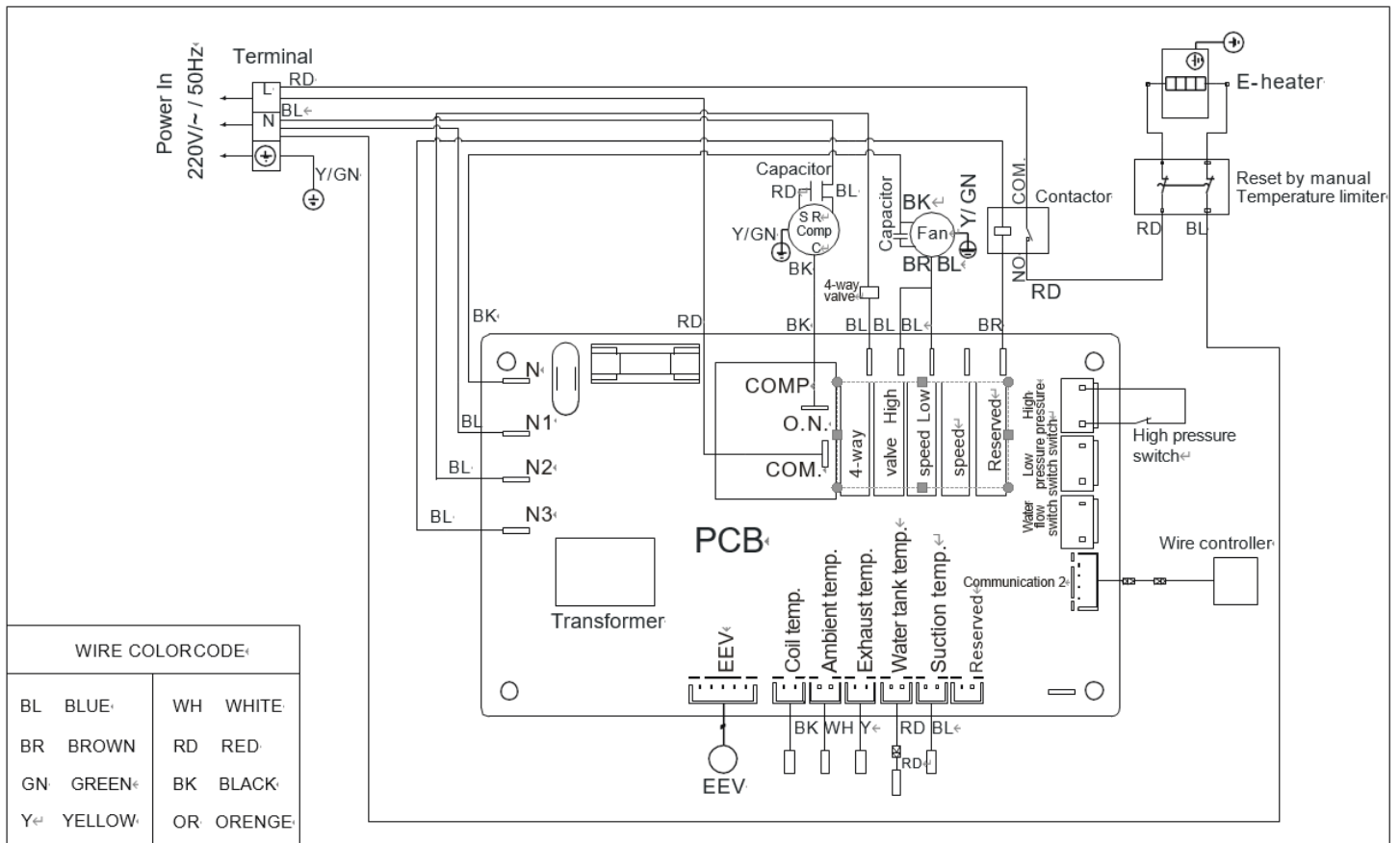

Method of Application

When using the unit, please operate to the following order:

1. Feeding water: when use the unit for the first time (or reuse it after the tank is empty), before connect the unit with power, please make sure the tank is full of water. Water feeding method (as below picture)

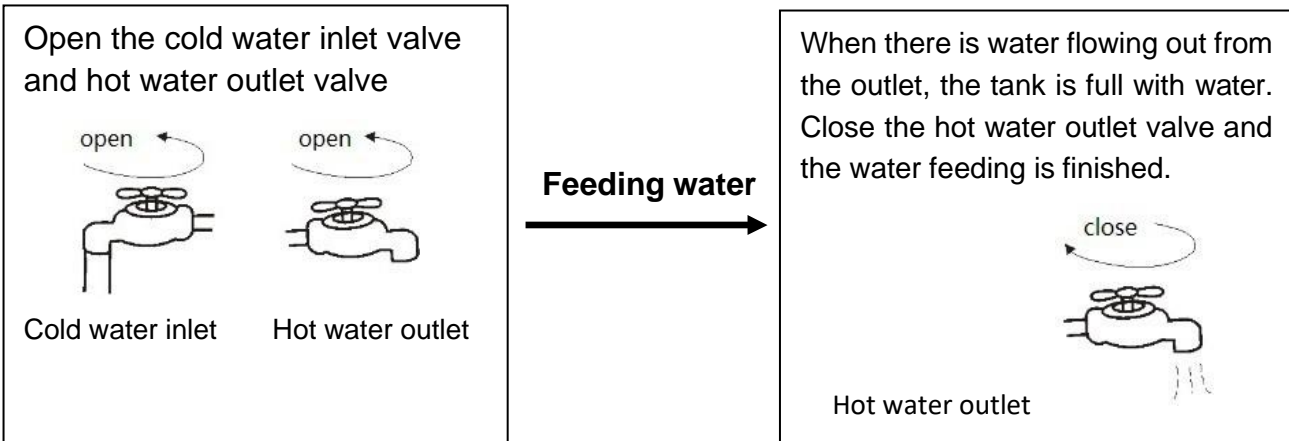

Operation without water in water tank may result in the damage of auxiliary E-heater. Due to such damage, manufacturer will not be liable for any damages caused by this issue.

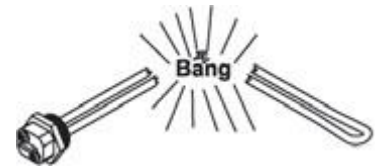

2. Plug in to connect the unit with power. Then the screen is bright which shows that the unit is connected with power. The user can realize different models by clicking the relative button on the screen (see next page);

Water temperature over 50°C can cause severe burns instantly or death from scalds. Children, disabled and elderly are at highest risk of being scalded. Feel water before bathing or showering. Water temperature limiting valves are recommended



3. Water draining: before cleaning or moving the unit, please drain out the water in the water heater. The draining method as below picture:

Close the inlet valve Open the outlet valve
Open the draining valve

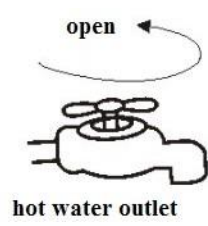
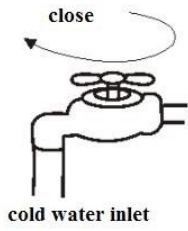

Draining water

After the draining, please screw the nut of the drainage outlet; the water draining is finished.

screw tightly

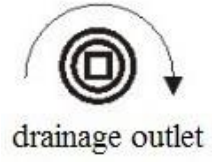

Instruction of operation

1. Control system specifications

(1) Operating condition

- Voltage: 220V \sim \pm 10%, 50Hz \pm 1Hz.
- Ambient temperature: -7 \sim +43 $^{\circ}$ C
- Storage temperature: -20 \sim +75 $^{\circ}$ C
- Relative humidity: 0 \sim 95%RH
- Temperature accuracy: \pm 1 $^{\circ}$ C

(2) Main function

















- Display the pool temperature and setting temperature, and also can query the coil temperature, ambient temperature and exhaust temperature and so on.
- Power cut memory function.
- When power cut, the clock will still work.
- Timing on/off.
- Automatic defrosting.
- Forced to defrost.
- Large LCD display.
- Has perfect protection function.
- The error code display and query
- Key-Lock Function
- Anti-freezing function
- When there is no wire controller or wire controller is broken, the system can recognize it, and control the heat pump to run automatically.

2. Wire controller and operation















1) Controller Instruction

symbol	status	meaning
	Constantly bright	heat pump is on
	Extinguished	Heat pump is off
	Constantly bright	at cooling mode
	Constantly bright	at heating mode
	Constantly bright	need repair
	Constantly bright	at AUTO mode
	Extinguished	Currently in the manual set temperature state
	Constantly bright	this unit is a water connection heat pump
	Extinguished	this unit is a refrigerant connection heat pump
	Constantly bright	heat pump is on and at defrosting
	Flashing	Heat pump is on and at defrost delay
	Flashing	heat pump is off and at refrigerant recovery status
	Constantly bright	electric heater is on for quick heating
	Flashing	electric heater is on for disinfection
	Constantly bright	current water temperature in the tank
	Constantly bright	set water temperature in the tank
	Constantly bright	current outlet water temperature
	Constantly bright	current inlet water temperature
	display	Display actual water temperature, set water temperature and fault code

	Constantly bright	Currently showing Celsius temperature
	display	Show real time
	display	Timer function is on
	display	Currently in the on-time working hours
	Flashing	set start time for working time
	display	Currently at boot time, non-working time
	Flashing	end time of current set working time
1	Constantly bright / Extinguished	Timing working period 1, always on when set, at other conditions are off.
2	Constantly bright / Extinguished	Timing working period 2, always on when set, at other conditions are off.
3	Constantly bright / Extinguished	Timing working period 3, always on when set, at other conditions are off.
	Constantly bright	start timing water return function
	Flashing	start manual water return function
	Extinguished	turn off water return (timing/manual) function
	display	Currently the return water is in regular timing working period
	Flashing	Current set start time of backwater working time
	display	Currently the return water is in the non-working hours
	Flashing	Currently set end time of water return period
1	Constantly bright / Extinguished	Timing zero cold water period 1, always on when setting, at other conditions are off.
2	Constantly bright / Extinguished	Timing zero cold water period 2, always on when setting, at other conditions are off.
	Constantly bright	The button is locked
	Constantly bright	The controller is connected to the router

2) Instruction of the buttons

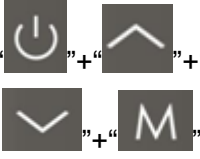

	button		instruction
1	Power/exit button		<ol style="list-style-type: none"> 1. Press and hold for 1 second to turn on/off. 2. In the query state, click this button to return to the main interface.
2	up		<ol style="list-style-type: none"> 1. Press at main interface to set the temperature. 2. Press and hold for 3 seconds in the power on/off state to enter the query state. 3. In the query status, press and check status 4. At parameter set status, press to modify parameters

3	down		<ol style="list-style-type: none"> 1. Press at main interface to set the temperature. 2. Press and hold for 3 seconds in the power on/off state to enter the query state. 3. In the query status, click to status query 4. Under parameter setting state, click parameter to modify
4	Mode button		<ol style="list-style-type: none"> 1. In the main interface, press and hold for 3 seconds to start (and enter zero cold water time setting) / turn off the timing zero cold water function; (when parameter 64=1) 2. In the main interface, short press for more than 1 second to cancel the zero cold water function in this period; (when parameter 64=1) 3. In the main interface, short press within 1 second to activate/deactivate the manual zero cold water function. (When parameter 64=1) 4. Under the main interface, click to switch between heating and cooling operation status (when parameter 64=0)
5	time		<ol style="list-style-type: none"> 1. In the main interface, press to enter the clock setting, and press to switch time "hour" and "minute". 2. In the main interface, press and hold for 3 seconds to start (and enter the timing time setting) / turn off the timing mode.
6	set		<ol style="list-style-type: none"> 1. Under the main interface, press to switch between automatic/manual temperature control mode. "AUTO" is displayed in the automatic mode and is not displayed when manual 2. In the main interface, press and hold for 3 seconds to enter the parameter interface.
7	Button combination	 "+" 	at main interface when ON, press and hold for 3 seconds to turn on/off quick heating
		 "+" 	at main interface when ON, press and hold for 3 seconds to turn on/off defrosting
		 "+" 	Within 5 minutes after power-on, at the main interface of shutdown, press and hold for 10 seconds to enter/exit refrigerant charging or recycling mode

			<p>Under the main interface, press and hold for 10 seconds to turn on/off the “sterilization” function manually (Parameter 66=1 is valid)</p>
			<p>Within 5 minutes after power-on, press and hold for 5 seconds to restore the factory parameter settings.</p>

2. Operation Instruction

2.1 turn ON/OFF the heat pump

When the controller is in the normal display state, press “” button for more than 1 second to switch the controller to the power on or off state. When heat pump is ON, “” lights up and is normally controlled. When heat pump is off, “” does not light up and the controller stops controlling output. The controller can display and operate normally in the power on state and off state. When the controller is powered on for the first time, it is in the off state. Then from the 2nd time, the state will be same as last time before power off.

2.2 Set the temperature control mode:

When the controller is in normal display state, press the “M” key to switch between manual temperature control mode and automatic temperature control mode;

The “AUTO” symbol lights up in the automatic temperature control mode, And the “AUTO” symbol does not light up in the manual temperature control mode;

In the manual mode, the heating/cooling water temperature is controlled according to the manual temperature setting value;

In the automatic mode, the hot water temperature is automatically adjusted according to the ambient temperature for control;



2.3 Set the water temperature:

In manual mode, press “^” or “v” key to enter the water temperature setting state. Then starts to display the setting symbol and display the corresponding water temperature set according to the current cooling or heating mode. When the water temperature is set, press the “^” or “v” button to increase or decrease the water temperature setting value; Press and hold the “^” or “v” button for more than 1 second to quickly increase or decrease the water temperature setting. Press and release the “” button immediately or no button operation in 5 seconds, controller will exits the modification and return to the normal display state. When the parameter value is modified, it will flash for 2 seconds and then return to the normal display state.

In the automatic mode, press the “^” or “v” key to enter the automatic temperature adjustable parameter deviation setting state. Then start to display the setting symbol and display the corresponding deviation setting value. Press “^” or “v” to increase or decrease the deviation setting value; press “^” or “v” for more than 1 second to quickly adjust or decrease the deviation

setting value; press and immediately release the “” button or no button operation in 5 seconds to exit the modification and return to the normal display state. When the parameter value is modified, it flashes for 2 seconds and then returns to the normal display state.



2.4 Real time clock settings:

In the main interface, click the “” button to enter the real-time clock setting interface; In the real-time clock interface, press the “” button, the hour part of the number flashes, press “^” or “v”, you can set the hour of the clock; when the hour part is set, press the “Time” button again, the number of minutes will flash, press “^” or “v” to set the minute of the real time clock; After the minute part is set, press the “” button again to confirm the real-time clock setting and return to the main interface;

In the real-time clock setting interface, if there is no button operation for 5 seconds, the current real-time clock setting value is confirmed, and the main interface is returned;

In the real-time clock setting interface, press the “” button to confirm the current real-time clock setting value and return to the main interface.

2.5 Timing work settings:

Press and hold the “” button for 3 seconds in the main interface to enable or disable the timed working mode. When the timed working mode is enabled, enter the timed period setting. Press and release “” to switch the hour and minute of the start time and end time of the three time slots in sequence., The value is flashing when switching to the corresponding value of the certain time slot. At the same time, “ON” or “OFF” symbol flashes, Press “^” or “v” to increase or decrease the corresponding value. After setting the timed period, press and immediately releasing the “switch” button or no button operation in 15 seconds, the changes can be saved and returned to the normal display state.

When the timing control mode is enabled, the corresponding symbols are displayed in the working period (ON) and the non-working period (OFF) respectively. In the power-on state, heating/cooling is performed only during the set working period, and the rest of the time is not heating/cooling. When the start time and end time of a certain working period are the same, it is regarded as canceling the timing period. When all timed periods are cancelled, it is considered to be in working hours throughout the day. If the start time of a certain working period is greater than the end time, the end time is considered to be the next day. The three time periods default to 05:00~07:00, 16:00~18:00, 20:00~00:00.

2.6 Set the cooling/heating mode:

With the controller in normal display, press “” to switch between cooling or heating mode. When switching to the cooling or heating mode, the cooling or heating symbol flashes quickly for 3 seconds and then returns to the normal display state. When switching to the cooling mode, the temperature judgment automatically selects “manual mode”, and the water temperature can be set

at this time. When the cooling/heating mode is switched, the compressor is allowed to start running after at least 3 minutes of stopping.

2.7 Forced speed heating:

When following conditions are met at the same time: the controller is in the normal display state and heat pump is in the power-on state.

Heat pump needs to be in the working period after the timing control is enabled.

The current heating mode is met and the temperature condition for continuing heating is satisfied, no other alarms that do not allow "speed heating" occur.

Press "M" + "^" button at the same time for more than 5 seconds, the "speed hot" function can be activated or deactivated. When the "speed heat" is running, the symbol lights up. If the heat pump is in cooling mode, "speed heat" is not allowed.

2.8 Forced defrosting:

When following conditions are met at the same time: the controller is in the normal display state and heat pump is in the power-on state.

Heat pump needs to be in the working period after the timing control is enabled.

The current heating mode is set and the set defrosting time is not zero and the temperature condition of the defrosting is continued, no other alarms that do not allow "frost" occur.

Press "M" + "V" button at the same time for more than 5 seconds to activate or deactivate the "Defrost" function. The symbol is illuminated when the "Defrost" is running. If heat pump is in cooling mode, "defrosting" operation is not allowed.

2.9 Forced sterilization:

If the controller is in the normal display state and it is currently in the heating mode, press the "M" + "^" + "V" button at the same time for more than 5 seconds to activate or deactivate the

"sterilization" function. The  flashes at this manual "sterilization" operation. When heat pump is in cooling mode, "sterilization" operation is not allowed.

2.10 Return time setting: (Fluorine cycle unit is valid; parameter 64=1)

Press and hold the "" button for 3 seconds in the main interface to enable or cancel the timed water return mode. When the timed water return mode is enabled, the timed return time

setting is entered. Press "" to switch the start time of the two time slots in turn, the hour part, the minute part, the hour part of the end time. The corresponding parts are flashed when the corresponding value is switched. The corresponding time period is displayed and the "ON" or "OFF" symbol is flashing. Press "^" or "V" to up or down and flashing to display the corresponding value.

After setting the timed period, press and immediately release the "" button or no button operation in 15 seconds, the changes can be saved and returned to the normal display state.

When the timing control mode is enabled, the corresponding symbols are displayed separately during the working period and the non-working period. In the power-on state, the water is automatically returned only during the set working period, and the remaining time is not returned. When the start time and end time of a certain working period are the same, it is regarded as

canceling the timing period. When all timed periods are cancelled, it is considered to be in an untimed return time period throughout the day. If the start time of a certain working period is greater than the end time, the end time is considered to be the next day. The factory default return water time is as follows:

A, time period 1 opening time: 6:30

B, time period 1 closing time: 7:30 C,

time period 2 opening time: 18:30 D,

time 2 closed time: 22:30

2.11 Query running status:

When the main interface of the power on or off is displayed, press and hold the “^” or “v” button for more than 3 seconds to enter the running status query interface; press and immediately release

the “^” or “v” button to check each operating condition; press and immediately release the  button or automatically return to the normal display state without any button operation in 30 seconds.

After entering the view mode, the last viewed data code (the default is “00” after power-on) and its corresponding value are displayed. After each press and immediately release the “v” button, the following table can be displayed in order:

name	code	remark
Fluorine cycle/water cycle heat pump	00	0=water cycle; 1=fluorine cycle
High pressure switch	01	0=disconnect; 1=close
Low pressure switch	02	0=disconnect; 1=close
Water flow switch	03	0=disconnect; 1=close
EEV value	04	Measured value
Evaporator coil sensor	05	Measured value
ambient temperature sensor	06	Measured value
absorption temperature sensor	07	Measured value
exhaust temperature sensor	08	Measured value
inlet water temperature (tank water temperature)	09	Display value = measured value + compensation value
outlet water temperature (return water temperature)	10	Display value = measured value + compensation value
compressor	11	0=stop; 1=running
4-way valve	12	0=stop; 1=running
high-speed fan	13	0=stop; 1=running
low-speed fan	14	0=stop; 1=running
circulation water pump	15	0=stop; 1=running
electric heater	16	0=stop; 1=running

2.12 Key lock:

When the controller is in the normal display state, the button is locked when there is no button operation for more than 60 seconds. Press any button at this time to unlock.

3. Control Output

3.1 Water temperature control

Normal water temperature control can be performed when the controller is turned on.

Heating mode:

When the water tank (inlet water) temperature \leq set temperature – return difference, heating begins;

When the water tank (inlet water) temperature \geq the set temperature, the heating is stopped;

Cooling mode:

When the water tank (inlet water) temperature \geq set temperature + return difference, the cooling starts;

When the water tank (inlet water) temperature \leq the set temperature, the cooling stops.

3.2 Electric heater control:

At heating mode, when the water tank temperature \leq set temperature -20 °C, electric heater starts,

and the symbol  lights up;

When the water tank temperature \geq the set temperature, the electric heater is turned off and the symbol is extinguished.

3.3 Circulating pump control (water circulation heat pump):

When defrosting, water pump is forced to run.

When cooling or heating, it is turned on 10 seconds before the compressor and stops 30 seconds after the compressor.

Antifreeze mode:

When the controller is powered on, whether heat pump is off or on, when the ambient temperature is too low, water pump will enter antifreeze mode to prevent the circulation line or the water tank from freezing. The specific conditions for enabling and disabling the environment for low temperature antifreeze are as follows:

1. When the ambient temperature is ≤ 2 °C, and the duration of the circulating water pump is off for more than 30 minutes, the circulating water pump is forcibly started for 60 seconds;
2. Exit the antifreeze mode when the ambient temperature rises to ≥ 4 °C.
3. When the ambient temperature sensor is faulty, it is mandatory to start the circulating water pump periodically, and run for 60 seconds every 30 minutes.



3.4 Circulation pump control (optional: fluorine cycle heat pump)

3.4.1 manual water circulation

When the controller is in the normal display state, click the “” button to start the manual water circulation function. At this time, the “Back Pump” icon flashes.



The manual return water control is as follows:

A, no pipe temperature sensor

When the manual return water function is activated, the water pump is started. After 30 seconds, the buzzer sounds three times, prompting the user to use the hot water; after 30 seconds, the “” icon flashes 3 times and the buzzer sounds for 3 seconds. Turn off the water pump and the “”



icon goes out (if the timed water is set before, the “Back Pump” and “Timer” icons are displayed). During this process, press and hold the “cold and hot” button for 1 second to manually cancel the manual water return function.

B, there is a pipe temperature sensor

When the manual return water function is activated, if the return water pipe temperature is $<35^{\circ}\text{C}$ (default 35°C), and the current water tank temperature \geq return water set temperature + return water temperature difference, return water pump will starts. If the return water pipe temperature \geq back water set temperature + return water temperature difference for 5 seconds or temperature control return water time \geq 2 minutes, the buzzer sounds three times, prompting the user to use hot water; after 30 seconds, the "  " icon flashes 3 times, buzzing the device will beep for 3 seconds, the water pump will be turned off, and the "  " icon will be off (if the timed water is previously set, the “Back Pump” and “Timer” icons will be displayed).

During this process, press and hold the “cold and hot” button for 1 second to manually cancel the manual water return function.

3.4.2 Timed return water:

When the controller is in the normal display state, press and hold the "  " button for 3 seconds to start or turn off the timed water return function; the "  " icon lights up when it is turned on, and the "  " icon turns off when it is turned off.

The timing return control is as follows:

A, no return water temperature sensor

When the timing water returned function is activated and the timed start time is reached, the water pump is started. After 30 seconds, the water pump is turned off, and the buzzer sounds three times, prompting the user to use the hot water; After 15 minutes, the water pump is started again and the cycle is repeated. .

If press and hold the "cold hot" button for 1 second or the timed return water close time is reached in this process, the timed water return function will be turned off (the return water function is still valid for next time, unless the timed return function is turned off).

B, there is a return water temperature sensor

When the timing return water starts, and the start time reaches, if the return water pipe temperature $<$ return water set temperature, and the current water tank temperature \geq return water set temperature + return water temperature difference, the return water pump will start. If backwater pipe temperature \geq return water set temperature + return water temperature difference for 5 seconds or temperature control return water time \geq 2 minutes, the water pump will turn off. The buzzer sounds three times, prompting the user to use hot water; When the pipe temperature $<$ return water set temperature, the water return pump is started again and the cycle is repeated.

If press and hold the "cold hot" button for 1 second or the timed return water close time is reached in this process, the timed return function will be turned off (the return water function is still valid for next time, unless the timed return function is turned off).

Note: When the return water temperature is faulty, it will automatically switch to the “no return water temperature sensor” mode.

3.5 Anti-fouling function

Sometimes the return pump/circulation pump stops for a long time, the pump will be rusted or scaled, and the pump needs to be started periodically.

After the pump has been on standby for 12 hours, it is forced to run for 1 minute.

3.6 High temperature sterilization control for Electric heater

Manual sterilization mode:

While the controller is in normal display state, press and hold the “M” + “^” + “V” button for more than 5 seconds at the same time, the heater symbol flashes to indicate that it enters the manual sterilization mode. At this time, the electric heater is started to heat the water to 75°C, And the water temperature is maintained at 70 to 75°C for 30 minutes, then the sterilization mode will be automatically exited.

After starting the manual sterilization function, press and hold the “M” + “^” + “V” button for 5 seconds or more at the same time to exit the manual sterilization mode.

When the water temperature setting value is $\geq 75^{\circ}\text{C}$, the sterilization function is not activated.

Automatic sterilization mode:

If the water temperature setting value is $< 75^{\circ}\text{C}$, the controller operation time reaches 7 days, the controller enters the automatic sterilization mode. Once the automatic sterilization mode exits, time begins from zero.

When the ambient temperature is $\geq 20^{\circ}\text{C}$, the electric heater is started at 1:00 am to start sterilization;

When the ambient temperature is $< 20^{\circ}\text{C}$, the electric heater is started at 15:00 pm to start sterilization;

After the automatic sterilization function is activated, the sterilization symbol flashes. At this time, the electric heater is started to heat the water to 75°C. And the water temperature is maintained at 70 to 75°C for 30 minutes, then the sterilization mode will be automatically exited.

When the water temperature setting value is $\geq 75^{\circ}\text{C}$, the sterilization function is not activated.

4. The Alarm

4.1. Low pressure fault:

After the compressor running for 5 minutes, if the low-pressure switch is detected to be in the off state for 10 consecutive seconds, the compressor immediately stops running. At this time, the controller displays the low-pressure fault alarm code “04E”. If the low-pressure switch is restored, error code does not occur. If no other protection or locking occurs, the compressor is restarted after 3 minutes.

If low-pressure fault protection appears 3 times within 1 hour, the controller will lock the protection. And the compressor will lock in the shutdown protection state. At this time, only the shutdown and restarting can unlock the compressor. The low-pressure switch is not detected during the defrosting.

4.2 high pressure failure:

After the compressor is started, if the high-pressure switch is detected to be in the off state for 10 seconds, the compressor immediately stops running. At this time, the controller displays the high-pressure fault alarm code “03E”. If the high-pressure switch is restored, error code will not occur. And if no other protection or locking occurs, the compressor is restarted after 3 minutes.

If high-pressure fault protection appears 3 times within 1 hour, the controller will lock the protection, and the compressor will be locked in the shutdown protection state. At this time, only the shutdown and restarting can unlock the compressor.

4.3 high exhaust temperature failure:

After the compressor starts running for 1 minute, when the exhaust gas temperature is detected to be higher than or equal to the exhaust high temperature protection value by 110°C for 10

consecutive seconds, a high exhaust temperature alarm occurs and the compressor stops. At this time, controller shows high temperature fault alarm code "02E". When the exhaust temperature drops back to 90°C, the alarm is released and the normal temperature control function is restored. If high temperature fault protection appears 3 times within half an hour, the controller will lock the protection. And the compressor will be locked in the shutdown protection state. At this time, only the shutdown and restarting can unlock the compressor.

4.4, water flow failure (water cycle model):

After the circulating water pump starts, it detects that the water flow switch is in the off state for 10 seconds, then heat pump stops. At this time, the controller displays the water flow switch fault alarm code "01E". Periodically (1 minute) restarts the water pump and 10 seconds later, the flow switch is detected. If water flow switch is closed, heat pump will go to normal running. If the fault occurs 3 times within 1 hour, the fault is locked and heat pump will not start.

4.5, antifreeze protection (water cycle model):

When the controller is powered on, when the ambient temperature too low, it will enter the antifreeze mode to prevent the circulation line or the water tank from freezing.

When the ambient temperature is $\leq 2^{\circ}\text{C}$, heat pump enters the first-class antifreeze. When the circulating water pump continuously stops for more than 30 minutes, it starts for 60 seconds, then repeats the cycle.

When the ambient temperature is $\leq 2^{\circ}\text{C}$, and the water tank temperature is $\leq 5^{\circ}\text{C}$, heat pump enters the secondary anti-freeze protection, Heat pump automatically turned on for heating. When the ambient temperature $\geq 4^{\circ}\text{C}$ or the tank temperature $\geq 15^{\circ}\text{C}$, heat pump stops heating and exits the secondary frost protection

4.6 low ambient temperature protection:

When the ambient temperature is $\leq -9^{\circ}\text{C}$, the compressor is prohibited from running. When the ambient temperature is $\geq -7^{\circ}\text{C}$, normal operation is resumed, this protection has no fault display.

4.7 water temperature too low protection at cooling mode (water cycle heat pump)

In the cooling mode with compressor running for 5 minutes, if detects that the outlet water temperature is $< 5^{\circ}\text{C}$ for continuous 5 seconds, heat pump enters subcooling protection. The compressor and the fan stop running, And the water pump operates normally. When the outlet water temperature is detected to be $\geq 7^{\circ}\text{C}$, heat pump exits the subcooling protection and enters normal operation.

4.8, water temperature too high protection at heating mode (water cycle heat pump)

In the heating mode, after compressor running for 5 minutes, if the water temperature is detected by continuous 5S $\geq 65^{\circ}\text{C}$, it is judged that the outlet water temperature is too high. It will shut down heat pump for protection and when the outlet water temperature is detected to be $\leq 60^{\circ}\text{C}$, the protection is withdrawn.

4.9, temperature sensor failure:

Heat pump will stop once the water tank temperature sensor or outlet water temperature sensor or ambient temperature sensor is faulty.

When absorb or exhaust or evaporator coil or water return temperature sensor is faulty, electric heater is allowed to operate.

When the return water temperature sensor fails, the return pump is allowed to run (do not judge the return water temperature)

When the water tank or ambient temperature sensor are faulty, electric heating operation is not allowed.

"11E", "12E", "13E", "14E", "15E", "17E", "18E", "19E" are correspondingly displayed when the coil temperature sensor, ambient temperature sensor, exhaust temperature sensor, inlet water temperature sensor/tank temperature sensor, absorb temperature sensor, and outlet water temperature sensor/return water temperature sensor are faulty.

10. Other:

"09E" is displayed when the communication between the main control board and the wire controller is abnormal or the data line is not connected normally. "----" is displayed when the valid clock cannot be obtained. And the communication indicator of the main control board flashes. The buzzer sounds when an alarm occurs. Press any key to silence the alarm.

The fault code table is as follows:

Error code	name
01E	water flow switch disconnected (water cycle heat pump)
02E	exhaust temperature too high
03E	high-pressure switch failure
04E	low-pressure switch failure
09E	communication failure
11E	evaporator coil temperature sensor failure
12E	ambient temperature sensor failure
13E	exhaust temperature sensor failure
14E	water inlet temperature sensor failure
15E	tank temperature sensor failure
16E	
17E	absorb temperature sensor failure
18E	water outlet temperature sensor failure
19E	return water temperature sensor failure
20E	outlet water temperature too high protection (water cycle heat pump)
21E	outlet water temperature too low protection (water cycle heat pump)

Pilot run of heat pump

Please confirm the followings before pilot run of heat pump

1. The heat pump has been finished well;
2. Assemble pipe and wire are all correct;
3. Drain water is smooth;
4. Insulation materials are complete;
5. Ground wire is installed well;
6. Power voltage is equivalent to rated voltage of heat pump;
7. Inlet and outlet air ports have no obstacle;
8. Air attached to water pipe is drained out, and all valve have been opened;
9. Leakage protection device works well;
10. Input water pressure is less than 0.6 Mpa;

Maintenance and Solution

I. Maintenance

1. Frequently check power plug and sockets and make sure both of them have been connected well and reliably, and have no over-heating effect;
2. When not used for a long time, especially where temperature is below 0°C, water
3. filled in the water tank must be drained out to prevent from damaging inner tank; (operation shown the above contents)
4. To make heat pump to keep a long-term and high efficiency working state, we
5. suggest you should clean inner tank up every half a year to remove accumulated sediment, please obey the following rules to clean inner tank:
 - (1). Turn off power supply of heat pump;
 - (2). Turn off cold water inlet valve, and open up hot water tap water;
 - (3) Connect drainage water with drain outlet through a soft pipe;(temperature resist of drainage pip is less than 93°C, if drainage pipe do not meet demands, please turn on cold water inlet valve, and turn on hot water tap water until water is not hot);
 - (4) Turn on drainage water port of heat pump, clean water tank attached to inner tank up, if
 - (5) needed, you will wash inner tank for many times to clear sediment;

(6) Turn off drainage water port, re-fill water into inner tank and recover power supply;

6. Each device has been matched with one anode rod, and anode rod will be slowly consumed during the process of protecting inner tank and extending use life. Under some water circumstance, anode rod and water can rise reaction, hot water will be quickly corroded and rise leakage when anode rod has been used up. We suggest check insulation materials every one year, if anode rod is used up, you can inquiry local server center or specific technical department to change a new one;

7. Used for enough hot water where we suggest user turn down settled temperature, which can reduce heat loss and avoid incrustation, meanwhile this work can help you save more electric energy and extend use life;

8. Filter should be cleaned up every one month to make sure heating effect;

9. If used for those regions which the temperature is below 0°C, you can take suitable measures to protect pipes in case the heat pump is installed outdoors for purpose of protecting connection pipe and keeping your normal life;

I. Error & Approaches

Error	Reason	Approach
The outlet water is cold; The screen is dark	The plug is not plugged properly. The temperature controller is on the lowest temperature control state; The temperature controller is damaged; The circuit board of the indicator lamp is damaged.	Plug in properly. Set the temperature of the controller in higher state. Inform the service man.
No water out from the hot water outlet	The tap water is cut off; The water pressure is too low; The tap water inlet valve is closed.	Waiting for the restore of the tap water. Wait and use when the water pressure is raised. Open the tap water inlet valve.
Water leakage	Bad tightness in the connecting points between pipes.	Improve the tightness of the connecting points

After-sale Service

If your hot water heater cannot operate normally, please turn off the unit and cut off the power supply at once, then contact with our service center or technical department.